

Equipment for Poultry

The AGRICULTURAL EXTENSION SERVICE maintains a county farm and home agent in each of North Carolina's 100 counties. They are assisted in many of the counties by assistant agents and by Negro farm and home agents. The Extension Service represents the United States Department of Agriculture, the North Carolina State College of Agriculture and Engineering, and the local county. County residents may secure full information about agricultural subjects by discussing the matter with these agents. Bulletins, printed material and other information may be obtained through the agents' office or by writing to the Agricultural Editor, North Carolina State College, Raleigh, N. C.

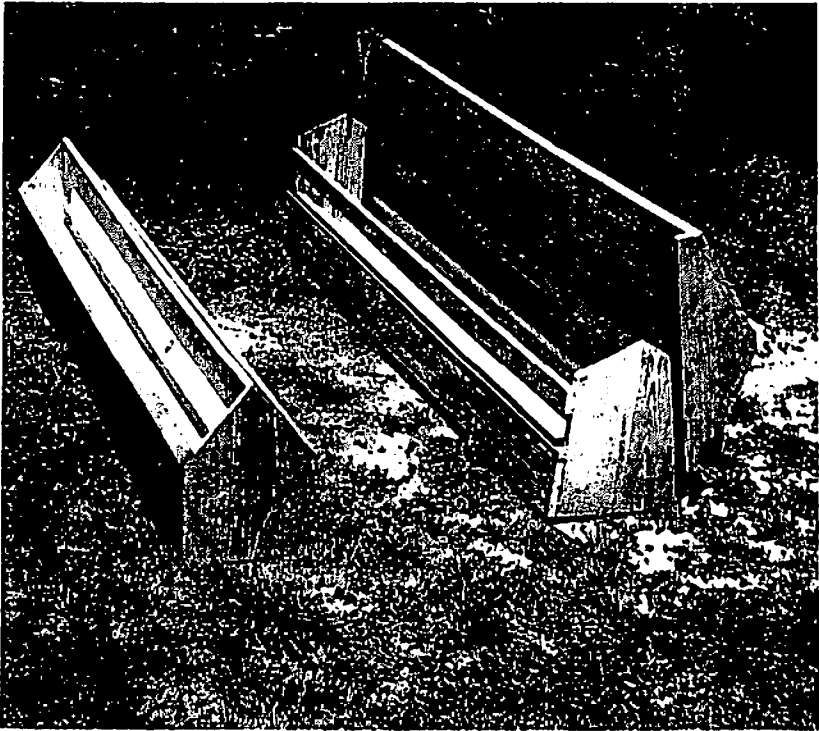

NORTH CAROLINA STATE COLLEGE OF AGRICULTURE AND ENGINEERING
 OF THE
 UNIVERSITY OF NORTH CAROLINA
 AND
 U. S. DEPARTMENT OF AGRICULTURE, COOPERATING
 N. C. AGRICULTURAL EXTENSION SERVICE
 I. O. SCHAUB, DIRECTOR
 STATE COLLEGE STATION
 RALEIGH

Equipment for Poultry

By

C. F. PARRISH and C. J. MAUPIN, *Extension Poultrymen*

R. S. DEARSTYNE, *Head, Poultry Department*

It is true that such factors as breeding, housing, care, and management all influence the results obtained from a farm flock, but there is another factor—good equipment—that plays an important part in the success or failure of the poultry enterprise. A satisfactory brooder, plenty of hopper space from which to feed, suitable and ample number of waterers, range shelters, adequate nesting facilities, roosting racks, catching hooks, nets, or screens, and incinerators or disposal pits with which to dispose of all dead birds, when properly used, make for better health and higher production of the farm flock. Regardless of the importance of good equipment and its relation to profit, it is relatively easy to find a flock owner following a good feeding program with good birds and houses, *yet using poor equipment.*

There is no real reason for this condition since most of the equipment needed on a poultry farm can be made at home. This bulletin indicates the construction or use of some poultry equipment that can be made or is already available on the farm. The equipment suggested is practical to use, is simple in construction, and relatively economical to build.

HOMEMADE BROODERS

There are a number of different types of homemade brooders used on farms in North Carolina, and each type appears to be giving satisfactory results. These homemade brooders are designed for a particular purpose and fill a definite need. When they are used with this objective in view, they are practical, economical to build, and easy to operate. The types presented here use one type of fuel—either oil, electricity, or wood, with the exception of the lamp brooder which may be heated with oil lamps or electric bulbs.

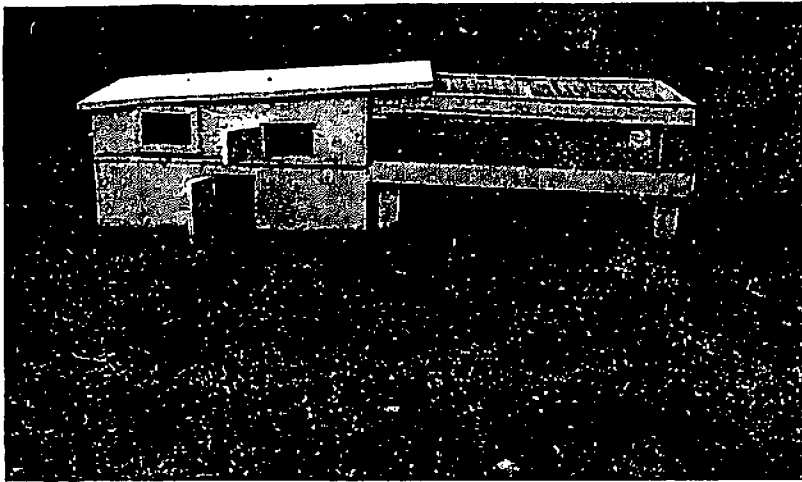

FIGURE 1. A HOMEMADE LAMP BROODER FOR 50-75 CHICKS.
(FUEL USED—OIL OR ELECTRICITY)

This brooder is designed for those persons who ordinarily raise a few broilers or chicks with hens and who do not care to raise more than 150-200 chicks a year. It is of simple construction, very easy to operate, and is heated either by electricity or by one to three oil lamps, depending upon the severity of the weather. Where it is desirable to heat this brooder with electric bulbs, a complete unit already assembled, including bulb, reflector, and thermostat for automatically controlling the heat, may be secured from an electric dealer, or parts may be purchased locally and a complete unit assembled at home. This brooder is to be operated in a protected place, and will accommodate 60 chicks until they are eight weeks of age. For construction details secure Extension Folder No. 52.

The homemade electric brooder enables the farmer to save from \$5.00 to \$10.00 on his initial cost, yet have a sturdy, economical and dependable brooder. Records kept on current consumption in this State show an average consumption of approximately $\frac{1}{2}$ kilowatt hour per chick during the normal brooding period. Satisfactory heating units can be purchased from any one of a number of reliable manufacturers of brooding equipment. With our increase in rural electrification, this brooder should grow more popular. For construction details secure Extension Folder No. 57.

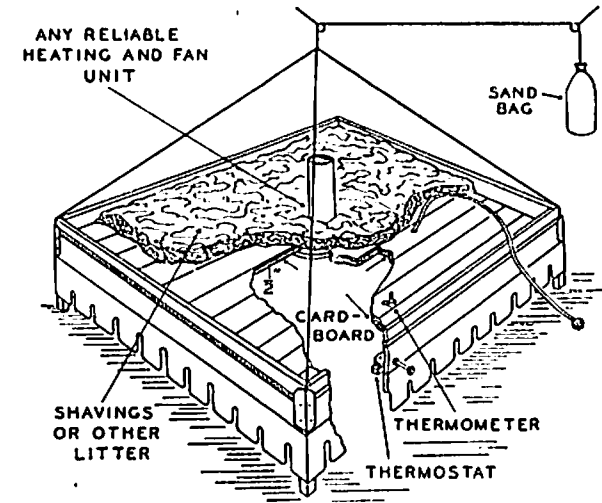

FIGURE 2. A HOMEMADE ELECTRIC BROODER FOR 300 OR 400 CHICKS.

HOMEMADE FEED HOPPERS

There has long been a need for waste-proof mash hoppers of low initial cost and simple in construction. While the type of hoppers indicated in this bulletin are not absolutely waste-proof, they do make for a minimum of feed waste.

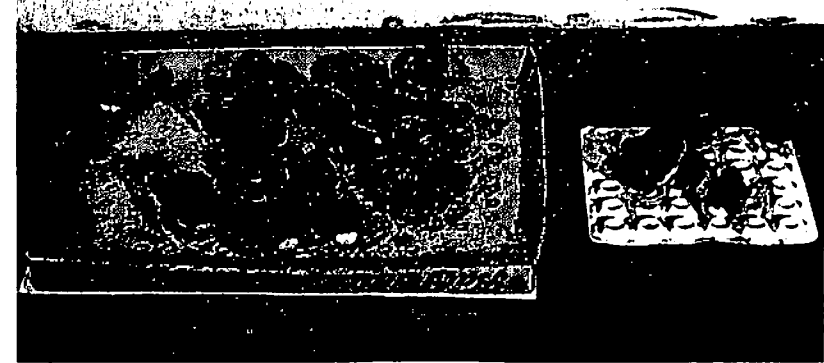
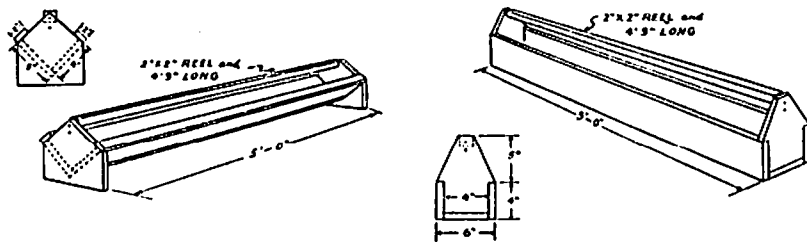

FIGURE 3. CHICK FEEDERS (FOR USE THE FIRST FEW DAYS).

The following suggested feeders may be used the first few days as baby chick feeders. A baby chick box lid, the new egg case cup type flat, or a wide board with laths nailed to the sides may be

used the first few days if chicks are free of pullorum disease. We would not recommend these types of feeders unless we felt the chicks were from pullorum disease-free sources. The lath feeder, which has been used very successfully in a number of states may be made from three laths that are four feet long. All of these feeders can be used the first few days, but they are soon outgrown and should be replaced with hoppers of greater capacity. Many sizes and types of metal hoppers are available on the market, and if metal feeders are desired, they may be purchased. Certainly some have advantages over homemade equipment.

Two types of intermediate size chick feeders are presented: the V-shaped trough, and the flat bottom feeder. The intermediate hoppers may be used by chicks two weeks old and can be used until the chicks are six or seven weeks of age. In some cases



FIGURES 4A AND 4B. CHICK FEEDERS—INTERMEDIATE SIZE (FOR USE BY CHICKS 2 TO 7 WEEKS OF AGE)

it may be necessary the first few days to bury or sink the feeder in the litter an inch or so or lay a plank alongside the hopper so that very small chicks may reach the feed more easily. A false bottom may be used to raise the level of feed the first two weeks.

Feed Hoppers for Growing Stock

Feed hoppers for growing stock may be either of the indoor or outdoor type. They may be of the V-shaped construction or may have a flat bottom. One each is presented here, the V-shaped type being for indoor use, and the flat bottom with cover is for use on range.

The indoor type hopper is of V-shaped construction and six feet long. Its sides are made from seven-inch and six-inch plank respectively, with a 1 x 2 inch strip nailed on the top of each side to prevent feed waste. A 1" x 3" or a 2" x 2" reel is to be used

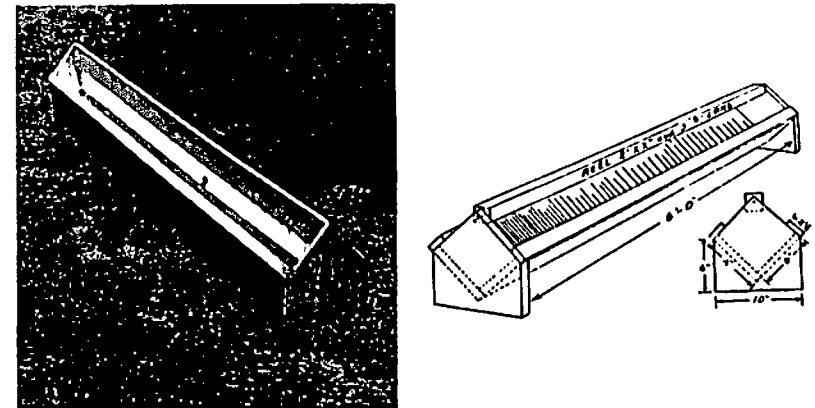

FIGURES 5A AND 5B. THE INDOOR TYPE FEED HOPPER.

over the indoor mash hopper to prevent birds from roosting or sitting on top of the mash hopper.

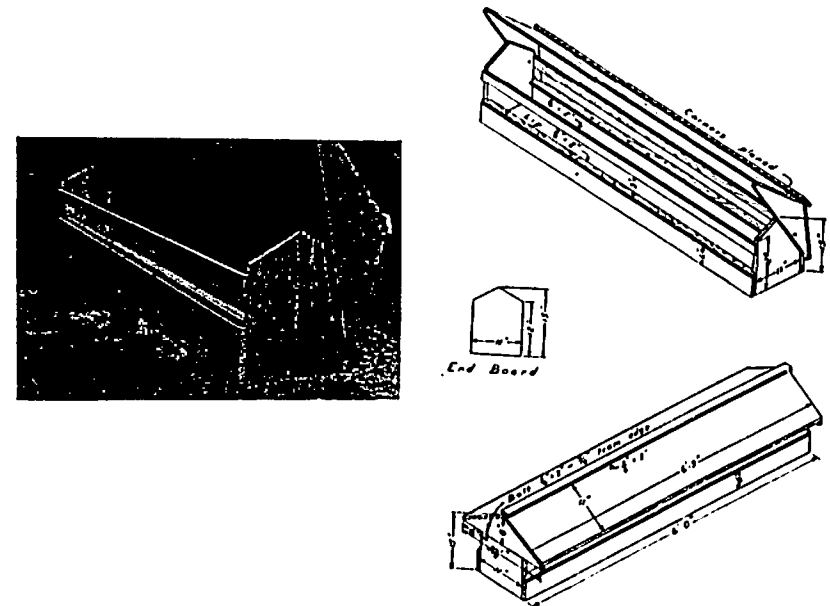

FIGURES 6A AND 6B. THE OUTDOOR TYPE FEED HOPPER.

It is generally agreed that this type of hopper is as near rain proof or weather proof as any mash hopper can be. It affords excellent protection and is ample in size for one hundred pullets. It is always well to locate feeders in the shade if at all possible,

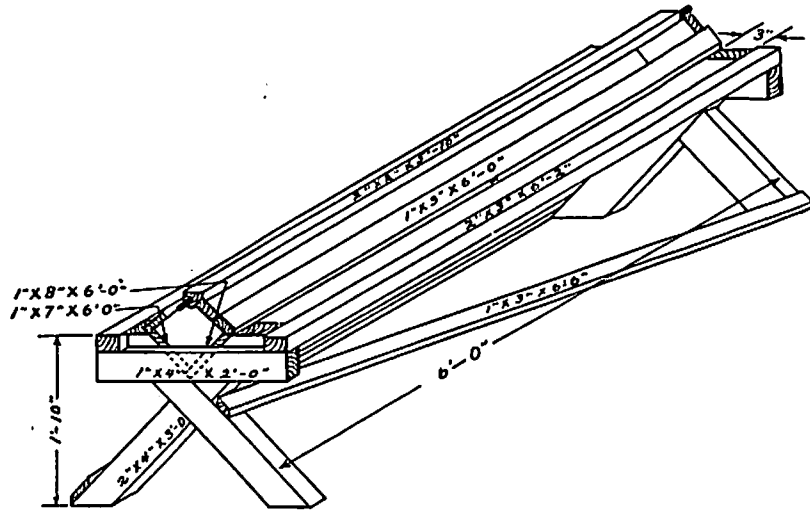

FIGURE 7. MASH HOPPERS FOR LAYERS—V-SHAPED TYPE.

or certainly a place protected from the extreme heat during hot summer weather. This type of outdoor range hopper works excellently with summer range shelters. At least one six-foot hopper should be provided for each 100 growing pullets.

The V-shaped type mash hoppers for layers as presented here, (See Fig. 7), with 1 x 3 inch strips for a lip, also a 2 x 2 inch reel over the top, is about as waste-proof as any mash hopper we know of. Birds seem to prefer this type mash hopper to the flat bottom type of hopper, for when the feed gets low the bill does not go on through and strike the wood as readily as where a flat bottom type mash hopper is used. Three V-shaped mash hoppers six feet long should be provided for each 100 laying birds.

WATERERS

One of the most important things in operating a successful poultry farm is the supply of water. Fresh, clean water should be available in adequate amounts at all times. To supply this it will be necessary to provide ample and suitable water containers. A variety of containers is presented here, these ranging all the way from an old tin pie pan and a discarded tin can up to the larger galvanized fountains with floats for automatically controlling the flow of water. Most any container that can be readily cleaned, that is large enough, and that will not permit the birds to get into it can be used as a water fountain. For small chicks,

fruit jars with small attachments, or a pie pan with an inverted can that sits inside the pie pan may be used (see Fig. 8). For range stock a satisfactory watering system can be made available by using a barrel which has a piece of pipe and a float attached (see Fig. 8a). This can be placed on a sled and pulled around

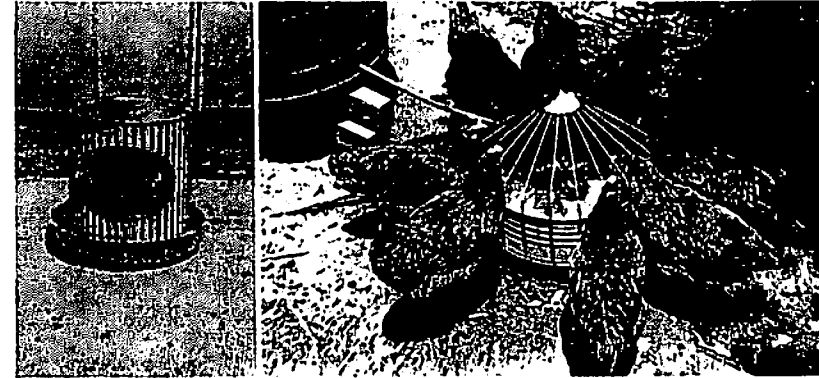

FIGURES 8 AND 8A. CHEAPLY CONSTRUCTED WATERERS.

from place to place and refilled each day. This makes a very excellent waterer, providing it can be located in the shade or artificial shade provided. Regardless of the type fountain used, it should be placed upon a wire covered frame to prevent a damp area around the water fountain or the chicks having access to a mud puddle or damp litter.

SUMMER RANGE SHELTERS

While a summer range shelter is a house, it is an essential and is one of the most valuable pieces of poultry equipment to farm people of North Carolina. It is constructed principally of wire, and has a tin, sack, or board roof. It is built up on skids and is portable. Every farmer with as many as 100 pullets should have a summer range shelter. The shelter is built in two sections—the base and the shelter proper. The base may be used in front of a brooder house in the winter time as the floor for a sun porch. For construction details secure plan No. 305.

NESTS

There is a division of opinion as to which is the better type of nest—the box nest or the so-called single nest. The double deck

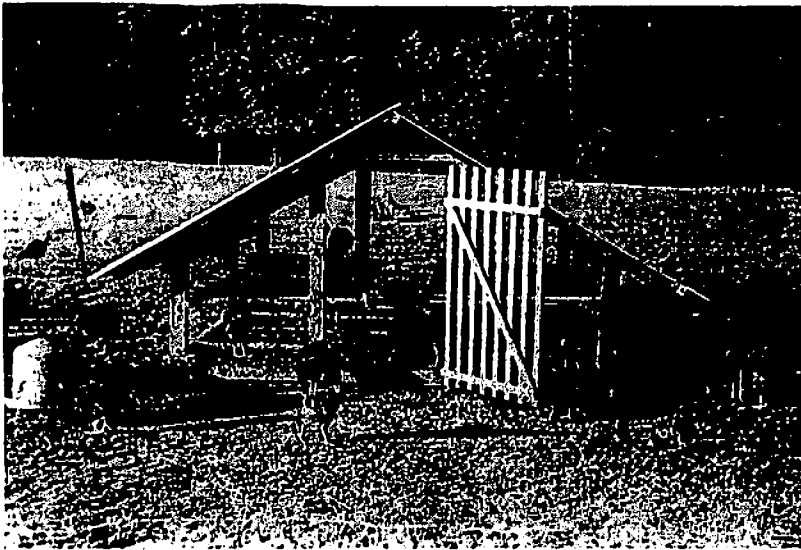

FIGURE 9. AN IDEAL WAY TO DEVELOP BETTER PULLETS.

individual nest type is recommended for North Carolina farmers. These nests may be placed on the sides of the laying house. They may be pulled out from the wall and turned around so that the birds have a dark nest, if this is more desirable. The main thing is to supply nests of ample size. Large birds need nests that are

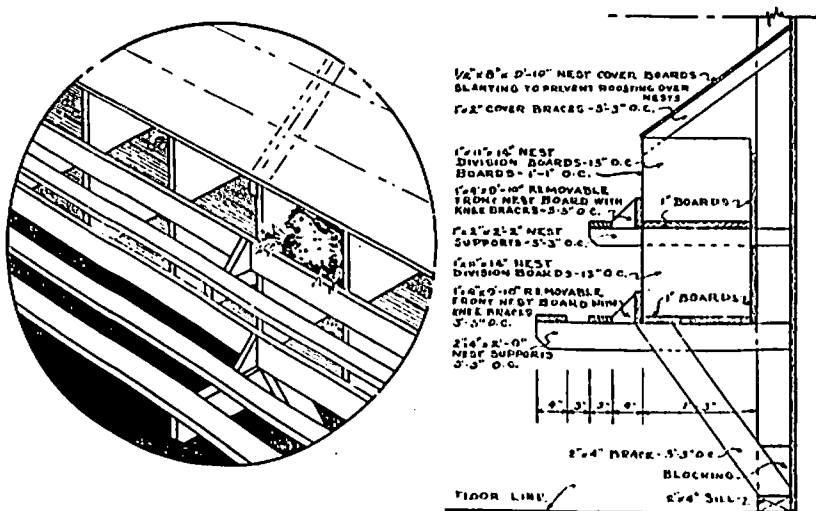

FIGURE 10. AMPLE NEST MAKES FOR MORE PROFIT.

deep, 14" deep, while smaller birds can use a nest 12" deep. At least twenty nests should be provided for every 100 layers. In the average house that accommodates 100 laying birds, 8 or 9 nests that are double deck may be placed on one end of the laying house and 2 or 4 nests may be placed on the other end. This permits the location of mash hoppers and drinking fountains in the center of the house.

ROOSTING RACKS

The roosting rack is rather a new piece of equipment to the average farmer in North Carolina. There are various types of roosting racks in use in North Carolina at the present time. The type presented here appears to be a very practical type of roosting rack, is widely used, and giving satisfactory results. The rack may be moved to the front of the house during extremely hot weather. This makes for better ventilation and for the comfort of the birds. Roosting racks are built in sections, each section usually being 8 feet long, 5 feet wide, and 24 inches high. For a 20' house two sections each 8' long are required. The roosting rack is covered with 1½" mesh, 16 gauge poultry wire, or 1" x 2"

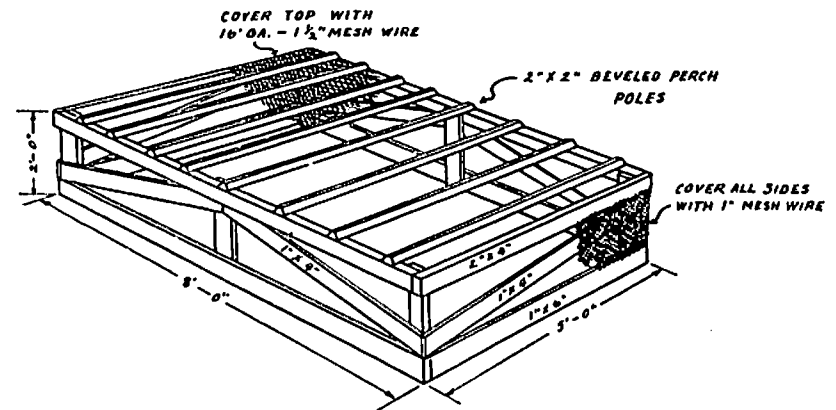
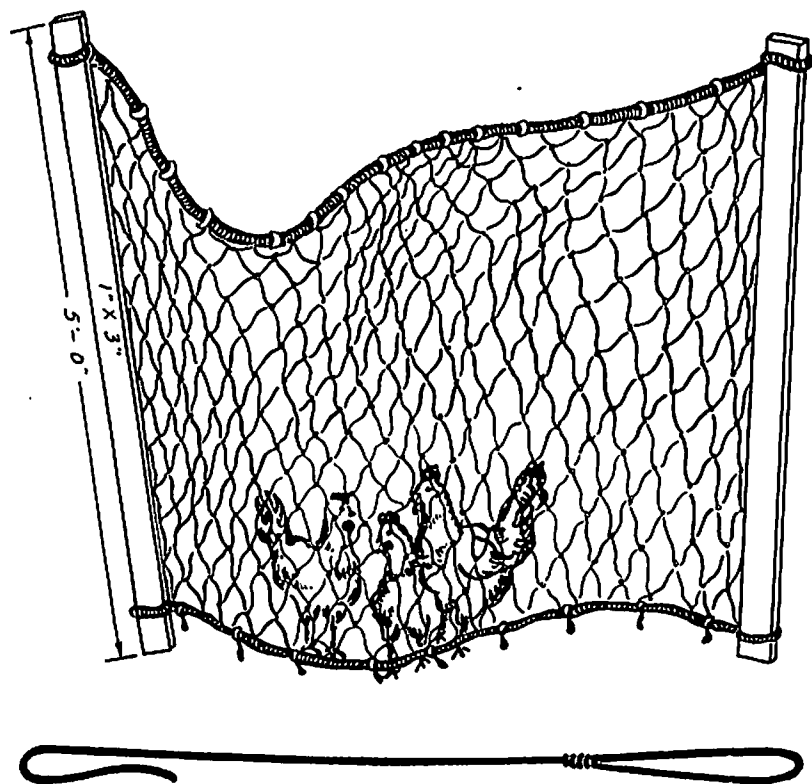

FIGURE 11. A PRACTICAL AND EASILY CONSTRUCTED ROOSTING RACK.

mesh, 14 gauge wire. The wire is 5 feet in width. The sides may be of wire or of strips. Wire makes for better circulation of air. Anything that will prohibit the birds from getting under the roosting racks or having access to the droppings will be satisfactory. When the roosting rack is not in use as such, it may be used temporarily as a coop for retaining market birds.



FIGURES 12A AND 12B. SOME PRACTICAL CATCHING EQUIPMENT.

CHICKEN CATCHING EQUIPMENT

Many farms in North Carolina do not have adequate equipment for catching of poultry. While there are a number of things that will give satisfactory results, catching screens or catching nets appear to be more favored. Some use catching coops, and where an occasional bird is to be hooked out, of course the catching hook is the more popular piece of equipment for this purpose; but where the entire flock is to be caught and handled, an old fish seine or tennis net makes excellent catching equipment. This net can be strung along the side or end of the house. The mesh is soft and will not cut the birds' combs and is preferred by many to wire screens. Any of these types of catching equipment may be used. Where wire is used the mesh of the wire should not be larger than $1\frac{1}{2}$ ".

BROODY COOP

While much progress has been made in breeding, there is still a need on most farms for a broody coop. This may be constructed indoors or out of doors. A practical outdoor broody coop may be 4 feet long, 4 feet wide, with the floor some 18 inches to two feet off the ground, and this enclosed with wire to prevent birds from



FIGURE 13. ONE TYPE OF BROODY COOP.

having access to the droppings. The broody coop can be used for a number of things, such as the retaining of surplus birds or the fattening of birds going to market, but should not be used by sick birds if broody birds are to be placed in this coop later and be reintroduced into the flock.

INCINERATOR OR DISPOSAL PIT

It has been said that sanitation, isolation, and cremation of dead birds are very essential in any disease control program. We agree that all birds dying of disease should be cremated.

An old steel drum and some pipe can be used to make a good incinerator. However, for many this is not practical, so a disposal pit is recommended as being more practical to dispose of dead birds at all seasons of the year. See Plan No. 353.

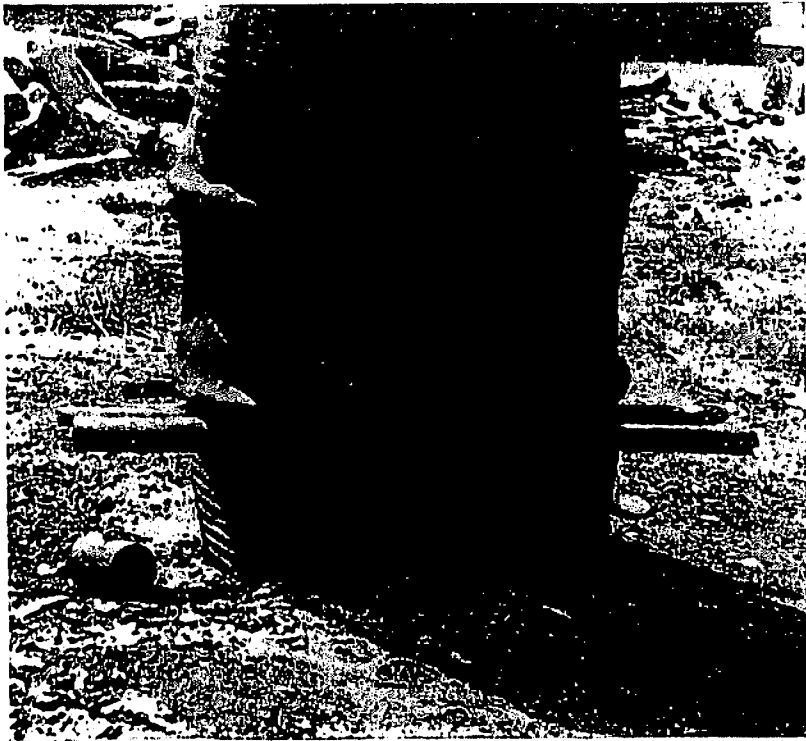

FIGURE 14. A HOMEMADE INCINERATOR.

OTHER PUBLICATIONS

The following other poultry publications may be secured upon request to your county agent or to the Agricultural Editor, State College, Raleigh:

Ext. Circular No. 154, Common Diseases of Poultry.

Ext. Circular No. 156, Culling.

Ext. Circular No. 158, Feeding for Egg Production.

Ext. Circular No. 160, Parasites of Poultry.

Ext. Circular No. 239, Grazing Crops for Poultry.

Ext. Circular No. 241, The Use of Disinfectants in Poultry Production.

Ext. Circular No. 244, Poultry Breeding as a Means of Flock Improvement.

Ext. Circular No. 251, Chick Raising and Range Management.

Ext. Folder No. 36, A Homemade Brick Brooder.

Ext. Folder No. 43, The Egg Cooler.

Ext. Folder No. 52, The Lamp Brooder.

Ext. Folder No. 53, Producing, Handling, and Marketing Quality Eggs.

Ext. Folder No. 57, A Homemade Electric Brooder.

Ext. War Series Bulletin No. 1, Wartime Poultry Feeding.

Blueprints for the construction of brooder houses, summer range shelters, and laying houses may be secured from county agents or from the Extension Poultryman, State College, Raleigh.